

ART. 8044

Cerniera mm 70x40 sp. mm 1,5 aisi 304 / A2

Hinge mm 70x40 THK mm 1,5 aisi 304 / A2

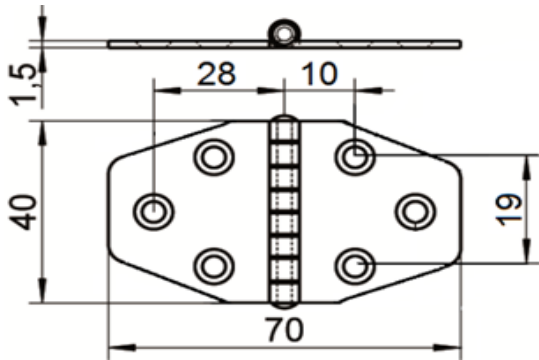

Ø Fori 4,3 mm
Ø Holes 4,3 mm

Svasatura 8 mm
Countersinking 8 mm

Con spina Ø 4 mm ribadita
With ø mm 4 riveted pin

disponibile anche Linea Blister
Also available Blister Line

INOXPOINT

Codice Articolo
Item Number



Box



Master carton



Pallet

Codice Articolo
Item Number



Box



80443807004	25	300	12000	0000051302	10 Blister	(1 blister = 1 pz)
-------------	----	-----	-------	------------	------------	--------------------



Attenzione!!! Le dimensioni riportate nelle schede tecniche, possono subire variazioni minime da lotto a lotto e a seconda della produzione.

In particolare, non praticare i fori prima di ricevere il prodotto.

Pay attention!! The dimensions shown in the data sheets are subject to minimal variations (different production line batch).

In particular, do not drill the holes before receiving the product.