

ART. 8053

Chiusura a leva tipo H aisi 304 / A2

Toggle latch type H aisi 304 / A2

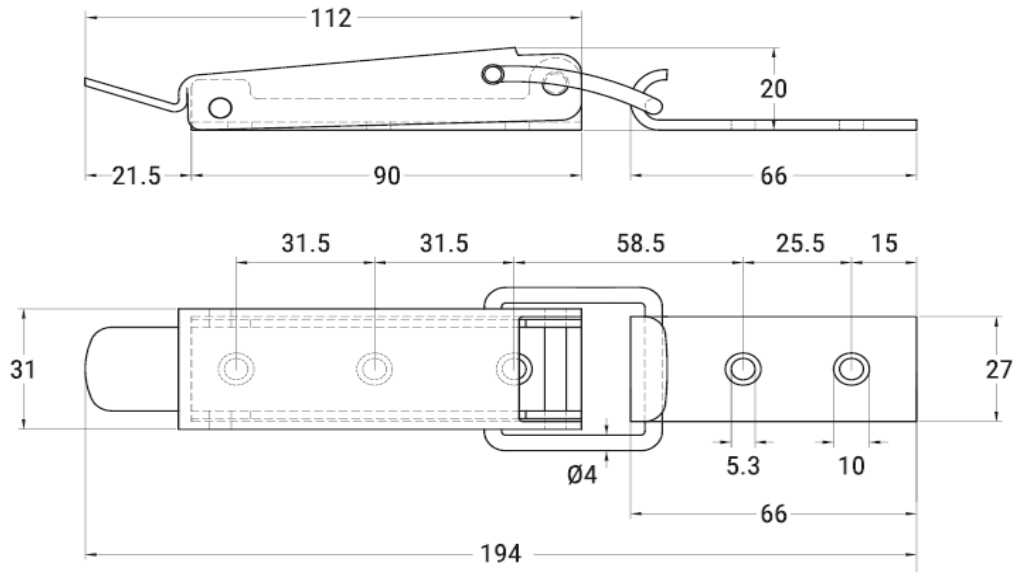

Codice Articolo
Item Number

Carico massimo di lavoro
Max safe load
(Kg ca.)

Carico massimo di tensione
Ultimate Tension
(Kg ca.)



Box



Master carton

8053800004

203

407

12

24



Attenzione!!! Le dimensioni riportate nelle schede tecniche, possono subire variazioni minime da lotto a lotto e a seconda della produzione.

In particolare, non praticare i fori prima di ricevere il prodotto.

Pay attention!! The dimensions shown in the data sheets are subject to minimal variations (different production line batch).

In particular, do not drill the holes before receiving the product.